

Standard Supplementary Regulations for the FIA European Historic Sporting Rally Championship RALLY BOHEMIA HISTORIC (CZE) - 10-12.07.2015



C Z E C H R E P U B L I C

PROGRAMME

26.5.2015: Opening date for entries.

26.6.2015: Closing date for entries.

9.7.2015, 15:00 – 19:00: Road Book issued to Competitors.

9.7.2015, 17:00: Start of reconnaissance.

9.7.2015, 15:00 – 19:00: Competition numbers and documents issued to Competitors at Rally Office. Signing on, administrative checking and scrutineering of cars.

10.7.2015, 19:30 – 21:00, (Staromestske namesti, Mlada Boleslav, GPS: 50.4111464N, 14.9027556E): Ceremonial start recommended for all drivers with their cars. Mandatory for invited drivers. This is the only start ramp provided. Press conference with invited crews will be held on the same place.

11.7.2015, 07:00 – 10:30, (11th gate of Skoda Auto factory, Trida Vaclava Klementa, Mlada Boleslav, GPS: 50.4266611N, 14.9209892E): Administrative checking and scrutineering (incl. the tyre marking) according to the following schedule:

Time of scrutineering will be written to each technical card to each crew according to their interest to drive at shakedown. Note: A tyre marking session will be held during the scrutineering.

10.7.2015, 17:30 (Dum kultury, Dukelska 1093, Mlada Boleslav, GPS: 50.4136147N, 14.9124117E) - Headquarters: First stewards' meeting.

11th July 2015

09:30 - 12:00 Shakedown Hrdloreyz for cars 1-20

09:30 - 12:30 Shakedown Hrdloreyz for cars 21 -

12:30 List of crews admitted to start and exact start times. Cars enter start park area 10 minutes prior their start time.

14:00 Start of 1st leg (Sychrov).

23:30 End of 1st leg (Mlada Boleslav) - Parc Fermé.

23:50 Publication of partial unofficial classification of 1st leg.

23:50 Publication of starting order for 2nd leg.

12.7.2015

08:00 Start of last leg (Mlada Boleslav).

13:06 Finish of last leg (Mlada Boleslav, Staromestske namesti) - Parc Fermé.

13:50 Final checks (Customer center of Skoda Auto, GPS: 50.4189164N, 14.9152172E)

15:50 Publication of provisional final classification.

13:40 Press Conference (Mlada Boleslav, Staromestske namesti, near finish ramp)

17:00 Formal prize – giving (Skoda Auto Museum, Trida Vaclava Klementa, Mlada Boleslav, GPS: 50.4187797N, 14.9140264E)

1 - ORGANISATION

This Rally will be run in accordance with the FIA International Sporting Code («the Code») (and its appendices), the National Sporting Regulations (and its appendices) and the present Standard Supplementary Regulations for FIA Historic Sporting Rallies.

1.1 - Definition

Name of the Rally: RALLY BOHEMIA HISTORIC

Name of the organising club: Autoklub Bohemia Sport v AČR

Name of the National Sporting Authority: Autoklub České republiky, (A.C.C.R)

ASN visa No. **HA00215** issued on **21 April 2015**

FIA visa No. **CRH/RBH/CZE.10.07.15** issued on 13 May 2015

1.2 - Organising Committee:

Chairman: Pavel Dušánek

Members: Petr Eliáš, M.Sc., Petr Pavlát, Jan Šrámek, B.Sc., Bronislav Mocek, Jan Peškař, Viktor Trnka, M.Sc.

Rally Secretariat / Permanent Secretariat:

Autoklub Bohemia Sport v AČR

Sosnová 200, 470 01 Česká Lípa

Czech Republic

Phone: +420 487 874 805

E-mail: historic@rallybohemia.cz

Website: www.rallybohemia.cz

Official Notice Board

Place: **Dum kultury, Dukelska, 1093, Mlada Boleslav**

GPS: **50.4136147N, 14.9124117E, www.rallybohemia.cz**

9.7.2015 16:00 – 22:00 Headquarters

10.7.2015 07:00 – 23:00 Headquarters

10.7.2015 18:00 – 23:00 service area

11.7.2015 07:00 – 02:00 HQ & service area

12.7.2015 07:00 – 19:00 HQ & service area

Press room:

Place: **Dum kultury, Dukelska, 1093, Mlada Boleslav,**

GPS: **50.4136147N, 14.9124117E**

10.7.2015 16:00 – 23:00 Headquarters

11.7.2015 07:00 – 01:40 Headquarters

12.7.2015 07:00 – 20:30 Headquarters

1.3 - Officials of the Rally

FIA chairman of the panel of stewards: Juha Rostedt (FIN)

Stewards: Bryan Brophy (IRL) - FIA

Stanislav Minařík (CZE)

FIA observer:

FIA eligibility delegate:

Assistant to FIA eligibility delegate:

Clerk of the course:

Assistant clerk of the course:

Assistant clerk of the course:

Safety officer:

Secretary of the Competition:

Scrutineers:

Alessandro Degan (ITA)

Ralf Pettersson (FIN)

Pat O'Dowd (IRL)

Petr Eliáš

Pavel Dušánek

Petr Pavlát

Jan Šrámek

Jan Mochan

Kamil Nechvilka

Competitors' relations officers:	Zdeněk Bělák
Competitors' relations officers:	Pavel Konečný
Competitors' relations officers:	Jakub Hofbauer
Press officer:	Aleš Holakovský
Medical officer:	Ivana Zýková
Chief road marshal:	Viktor Trnka
Public relations officer:	Petr Eliáš
Chief timekeeper:	Ladislav Just
Radio communications:	Pavel Vomáčka

1.4 - Amendments to the Regulations - Bulletins

The provisions of the present Regulations may only be amended according to Articles 3.6 and 11.9 of the Code.

Any amendment or additional provision will be announced by a dated and numbered bulletin which will be an integral part of the present regulations. These bulletins will be posted at the Secretariat and on the official notice board and will be directly communicated to the participants, who must acknowledge receipt by signature, unless this is materially impossible during the running of the Competition.

Any bulletin issued by the organisers before the start of the Rally (first stewards' meeting or beginning of scrutineering) must have received written FIA approval. Any bulletin issued after the start of the Rally must have received the prior approval of the stewards.

1.5 - Interpretation of the Regulations

1.5.1 - The clerk of the course is responsible for the application of the present Regulations and their provisions during the running of the Rally.

1.5.2 - Any protest concerning this application must be sent to the stewards for deliberation and decision (Article 13 of the Code).

1.5.3 - Similarly, any case not provided for in the aforementioned Regulations will be deliberated by the stewards, who alone have the authority of decision (Article 11.9 of the Code).

1.5.4 - In case of dispute on the interpretation of the present Regulations only the English language text will be deemed authentic.

1.5.5 - For the exact interpretation of this text the following definitions apply:

a) «Competitor» : either physical or legal entities.

b) «crew» : Driver and Co-driver.

1.5.6 - The Driver assumes the responsibility of the Competitor, when the latter is not on board the vehicle.

1.5.7 - Stages run on gravel: sections of the Rally declared as being run on gravel are decided by the clerk of the course.

1.5.8 - Crews (Driver and Co-driver) must report to the start (or ceremonial start) control, with their car and within their due time to be considered as starter.

2 - ELIGIBILITY

2.1 - FIA Title

The **RALLY BOHEMIA HISTORIC** counts for the FIA European Historic Sporting Rally Championship.

3 - DESCRIPTION

3.1 - Total distance of the course including the special stages (in km): 428,31

3.2 - Number of special stages: 13

3.3 - Total distance of the special stages (in km): 151,77

3.4 - Number of legs: 2

3.5 - Interval between cars: 1 minute

Throughout the Rally, the official time will be radio station Český Rozhlas – Dvojka on FM 89,9 MHz or 87,6 MHz.

The itinerary, time controls, passage controls, neutralisation periods, etc. are described on the time card and in the Road Book.

In case of discrepancy, the time specified on the time card is binding.

4 - ELIGIBLE VEHICLES

4.1 - Eligible vehicles are those listed in Article 2 of the «FIA European Historic Sporting Rally Championship» Sporting Regulations.

4.2 - The cars are divided into the classes stated in Article 2 of the «FIA European Historic Sporting Rally Championship» Sporting Regulations.

4.3 - At scrutineering, the Competitor must present the FIA Historic Technical Passport («HTP») to the FIA eligibility delegate who may keep it until the end of the Competition.

4.4 - Any disputes shall be decided by the stewards, following a report from the scrutineers and FIA eligibility delegate.

4.5 - All cars must be in conformity with the National Highway Code in their countries of registration.

5 - ELIGIBLE COMPETITORS - ENTRY FORMS - ENTRIES

5.1 - Any person or legal entity holding an FIA International Competitor's Licence valid for the current year is eligible.

5.2 - Where the Competitor is a legal entity, or is not part of the crew, the first Driver named on the entry form will be held entirely responsible for all the liabilities and obligations of the Competitor throughout the Competition. When the first Driver is not available, responsibility will be assumed by the Co-driver named on the entry list.

5.3 - Any incorrect, fraudulent or unsportsmanlike behaviour by the Competitor or members of the crew will be judged by the stewards, who will impose penalties which may go as far as exclusion.

5.4 - Anybody wishing to take part in the Rally must send the attached entry form, duly completed, to the Rally Secretariat *Autoklub Bohemia Sport v AČR, Sosnová 200, 470 01 Česká Lípa, Czech Republic* before 26.6.2015 at the latest. The entry form must be accompanied by at least one photo of the entered car.

Details concerning the Co-driver can be completed up to the start of scrutineering.

The entry form must be accompanied by a photocopy of the 1st page of the car's FIA HTP clearly showing its class and category, as attributed to the car by the issuing ASN.

No change of Competitor may be made after entries have closed 26.6.2015.

One member of the crew may be replaced with the agreement of:

- the organisers, before the start of the administrative checking;
- the stewards, after the commencement of these checks and before the publication of the list of crews eligible to take the start.

Only the FIA can authorise the replacement of both crew members.

5.5 - For foreign Competitors, Drivers and Co-drivers, authorisation must be given in accordance with Article 3.9 of the Code.

5.6 - No amendment may be made to the entry form except in cases provided for by the present Regulations. However, the Competitor may replace the car declared on the entry form by another from the same period and class up to the start of scrutineering.

5.7 - At scrutineering, if a vehicle does not correspond in its presentation to the category and/or class in which it was entered, this vehicle may, on proposal of the FIA eligibility delegate, be transferred to the appropriate class after decision of the panel of stewards.

5.8 - By signing the entry form, the Competitor and all crew members undertake to comply with all sporting prescriptions specified in the Code and to those of the present Regulations.

5.9 - The number of entries is limited to 70 vehicles.

5.10 Tyres

During Competitions classed as tarmac (i.e. excluding gravel Competitions) there shall be a maximum of 14 tyres permitted. Tyres must be «E» marked and uniquely identified with a barcode (or such other method as may be prescribed) and registered with the FIA eligibility delegate before the start of the Competition.

Checks for compliance with this regulation may be undertaken at any time during the Competition and any discrepancies will be reported to the stewards.

A detailed information sheet will be available before each Competition.

6 - ENTRY FEES - INSURANCE

6.1 - The entry fees for the Competition are fixed at: **800 €**

6.1.1 Entry fee must be paid to:

6.1.1.1 Payments in EUR:

Bank: KB Česká Lípa

Account owner: Autoklub Bohemia Sport v AČR, Sosnová 200, 470 01 Česká Lípa (CZE)

IBAN: CZ26 0100 0001 0766 9658 0257

BIC: KOMBCZPPXXX

6.1.1.2 Payments in CZK:

Bank: KB Česká Lípa

Account number: 107-6696580257/0100

6.1.3 In case of late payment, normal entry fee will be increased by **100 €**.

6.1.4 The entry fee includes:

- road book and other documents for the crew
- identification for 1 competition car
- identification for 1 assistance car "Service A" and 1 assistance "Service B", same conditions of Service A and B
- identification for 1 recce car
- identification for 2 drivers
- identification for 4 mechanics
- installation and rent of GPS monitoring system (only for FIA European Historic Sporting Rally Championship)
- small refreshment for the crew during the event (1 in leg)
- refreshment for 4 persons (ceremonial price giving on 12.7.2015) – other tickets can be bought by 10 Euro / 250 CZK

6.2 - The entry will only be accepted if accompanied by the total entry fees.

6.3 - Entry fees will be refunded in full:

- a) to candidates whose entry has not been accepted;
- b) in the case of the Rally not taking place.
- c) Organisers will refund minimum 80% of the entry fee to those competitors who, for reasons of «force majeure», duly certified by their ASN, were unable to start in the Rally.

6.4 - The organiser provides the following insurance at price 100 € (included in entry fee). Insurance cover will come into effect from the start and will cease at the end of the Rally or at the moment of withdrawal, disqualification or exclusion of the Competitor. The insurance policy covers the car against the damage caused to third party up to 351 000 € per participant. However the damage caused by drivers among themselves is not covered by this contract. The insurance for organizers and participants is made with an integral excess of 5 000 CZK. It means that damage up to 175 € won't be refunded and damage over 175 € will be covered without the deductible of insured.

6.5 - In case of accident, the competitor or his representative must notify the clerk of the course within 24 hours.

6.6 - On arrival at each leg the competitor must sign a declaration concerning any accident he may have had en route.

6.7 - The Organising Committee declines all liability due to consequences for breach of laws, regulations or prescriptions by Competitors in the countries they will cross, those consequences will be solely the liability of those who have incurred or committed them. The Organising Committee also declines all liability in case of riots, demonstrations, vandalism, natural disasters etc. from which Competitors or crew-members could suffer, or from the consequences thereof. Any damages, fines or penalties will be borne by them.

7 - ADVERTISING

Must comply with the Article 2.1.9 of Appendix K (see Appendix 6).

8 - GENERAL OBLIGATIONS

8.1 - Crews

8.1.1 - Only crews made up of two persons shall be admitted to the start. The two members of the crew will be nominated as first Driver and Co-driver. All members of the crew may drive during the Competition, and each must possess an FIA International Driver's Licence valid for the current year.

8.1.2 - The full crew must be on board the car throughout the entire duration of the Competition, with the exception of the cases provided for in the present Regulations. If one member leaves the car, or if a third person is admitted on board (unless this is to transport an injured person) the car shall be excluded from the Competition.

8.1.3 - An identity card bearing recent photos (4cm x 4cm) and the signatures of the two crew members and all the particulars of the car, must be displayed inside the car throughout the entire duration of the Competition and must be presented upon official request. Failure to do so may result in exclusion from the Competition.

8.2 - Starting order - Plates - Numbers

8.2.1 - The start of the first leg will be given in competition number order with the lowest number starting first. For safety reasons, this order may be modified at the request of the clerk of the course.

8.2.2 - The starting order for each of the following legs shall be determined according to the partial unofficial classification established at the end of the previous leg. For safety reasons, this order may be modified at the request of the clerk of the course.

8.2.3 - Any car reporting late for the start of the event, leg or section, shall be penalised by 10 seconds for every minute's delay. Any car arriving over 15 minutes late shall not be allowed to start.

8.2.4 - The Organising Committee will supply each crew with two Rally plates and three panels bearing the Competition numbers.

8.2.5 - The Rally plates must be fixed to the front and rear of the car in a visible position for the duration of the Rally. The Rally plates must not cover, even partially, the car licence plate. Any covering of the licence plate at any time during the event will incur a penalty.

8.2.6 - The number panels supplied by the organisers must be displayed on both sides and in front of the car for the duration of the Rally.

8.2.7 - If it is ascertained at any time during the event that:
- any Competition number or Rally plate is missing, a penalty will be imposed;

- any three Competition numbers or two Rally plates are missing at the same time, exclusion will be pronounced.

8.2.8 - The Rally plates and the Competition numbers will be available to all participants at the Rally Secretariat as from 9.7.2015 17:00 – 21:00. The Competitors must go to scrutineering only after having fixed the Rally plates and the Competition numbers. Cars not in conformity will not be verified.

8.2.9 - The names of the crew plus their national flags must appear on both sides of the wings at the front of the car (max size 10cm x 40cm). Any car failing to comply with this rule shall be subject to a penalty.

8.2.10 - If present, the winner of the previous year championship will be supplied with the Competition number 1, at organiser discretion.

8.3 - Time card

8.3.1 - At the start of the Rally, each crew will be given a time card, on which the times to cover the distance between time controls will be shown. The time card will be handed in at the finish time control of a section and will be replaced by a new one at the start of the next section. Each crew is solely responsible for their time card.

8.3.2 - The time card must be available at all times for inspection on demand, especially at the control posts where it must be presented personally by a member of the crew for stamping.

8.3.3 - Any correction or amendment to the time card which has not been approved by an official will result in exclusion from the Competition.

8.3.4 - The absence of a stamp from any control, or failure to hand in the time card at the specified control (time or passage control, regrouping halt control or at the finish) will result in exclusion from the event, except where the provisions of Article 9.3.6 - Catching Up, are applied.

8.3.5 - The crew alone is responsible for presenting the time card at the different controls and for the accuracy of the entries on the card.

8.3.6 - It is therefore up to the crew to submit the time card to the officials at the correct time and to check that the time is correctly entered. The time-keeper is the only person permitted to enter the time on the card.

8.4 - Traffic - Repairs

8.4.1 - Throughout the Rally, competitors must strictly observe the traffic laws. The penalties for infringement of traffic laws will be as follows:

- 1st infringement: cash penalty of 200 Euro,
- 2nd infringement: 5 min. time penalty,
- 3rd infringement: exclusion from the Rally.

Should the police decide against stopping the offending Driver, they may ask the organisers to apply the penalties set out in the present Regulations, subject to the following:

- notification of the infringement reaches the organisers through official channels and in writing, before posting the current results,
- the statements are sufficiently detailed for the identity of the offending Driver to be established beyond all doubt, as well as the place and time of the offence,
- the facts are not open to different interpretations.

8.4.2 - Repairs and refuelling are freely permitted throughout the Competition, except in those cases expressly forbidden by the present Regulations and/or by the official Road Book. Change of engine, gearbox or final drive during the Competition is forbidden. Failure to observe these rules may lead up to exclusion from the Rally, at the discretion of the stewards.

8.4.3 - Service cars are forbidden to park or to assist within 300 m of a control point. Any crew who is serviced in any forbidden zone defined in the Road Book will be subject to a penalty up to exclusion. For an offence of parking within a forbidden zone, a cash penalty of 200 Euro will apply.

8.4.4 - Service cars are forbidden to enter a special stage or any area that the organisers specify as prohibited, on a pain of penalty up to the exclusion of the Competitor.

8.4.5 - It is forbidden, under pain of penalty up to exclusion, to tow or transport the cars or to have them pushed, except in order to bring them back onto the road, or to clear the road.

8.4.6 - Crews are also forbidden, under pain of exclusion:

- a) to deliberately block the passage of competing cars or to prevent them from overtaking,
- b) to behave in an unsportsmanlike manner.

8.5 - Route reconnaissance

8.5.1 - Duration and conditions:

- a) route reconnaissance may be performed by the entered crews after receipt of the Road Book;
- b) reconnaissance must always be made in accordance with the Highway Code.
- c) competitors should have the opportunity to pass a minimum of 3 times and a maximum of 3 times through each special stage.
- d) the period of reconnaissance is fixed as follows:

9th July 2015

st. no.	SS Lobeč, Vinec, Sychrov, Šumberk, Bzí, Shakedown		SS Staroměstská		SS Bondy	
	start time	end time	start time	end time	start time	end time
1 - 20	17:00	21:00	21:00	22:30	23:00	0:00
21 -	17:15	21:15	21:15	22:45	23:15	0:15

10th July 2015

st. no.	SS Sychrov, Šumberk, Bzí		SS Lobeč, Vinec, Shakedown	
	start time	end time	start time	end time
1 - 20	8:00	13:30	12:30	17:30
21 -	8:30	14:00	13:00	18:00

8.5.2 - Registration

- a) Competitors or their representative must sign an ID form including details of the reconnaissance car and of the Driver. This form may be either faxed, e-mailed or handed to the Secretariat, upon collection of the Road Book.
- b) Reconnaissance material will be issued upon collection of the Road Book. Foreign Competitors may collect all relevant material the rally headquarters, therefore, the organisers must be notified well in advance of their arrival date and hotel.

8.5.3 - Specific restrictions

- a) All Drivers are authorised to cover each special stage a maximum of 3 times.
- b) An identification sticker, bearing the Competition number of the crew, will be issued for each car. This sticker must be displayed at the top (middle) of the front windscreen and remain visible during reconnaissance.
- c) Reconnaissance card is not used. All recce data (speed, 3 times cover of the stage, time) is covered by GPS tracking ONI system
- d) Maximum speed allowed on special stages, during reconnaissance, is 80 km/h, unless traffic signs indicate a lower speed limit. Within residential areas, this speed is limited to 50km/h, unless traffic signs indicate a lower speed limit.

Note speed limit: 80 km/h

- e) The stages will be open to the traffic; therefore, the safety and rights of other road users must be respected.
- f) In no circumstances may crews drive in the opposite direction in the special stages, unless given particular instructions to do so by the organisers, road marshals or the police. Competitors may enter a special stage only from the start.
- g) No more than two persons are permitted in the car during each passage through a special stage. One of these persons must be either the Driver or the Co-driver of the competing crew.

h) The organisers may monitor the behaviour of the Competitors on the reconnaissance route, by using any kind of means.

i) Should a Competitor's reconnaissance car have to be replaced for any reason whatsoever, he/she must inform the Rally Secretariat and give the details of the new car.

j) From the end of reconnaissance, any person connected with an entered crew, in any way whatsoever, is forbidden to travel (except on foot) on or over the route of a special stage of the Rally without express authorisation from the clerk of the course.

8.5.4 - Reconnaissance cars

All reconnaissance operations, for all crews, may only be carried out using standard road cars, including Jeeps or SUV cars or cars used for the Competition if they are identified as Standard Touring or Grand Touring cars. In general, no Competition modifications are allowed and reconnaissance cars must comply with the specifications defined in the following Regulations:

a) Series production car

b) The car must be painted in a single colour, with no advertising, stickers, etc.

c) The engine shall be a production engine (complying with the Group N Regulations).

d) The gearbox shall be a production gearbox (complying with the Group N Regulations).

e) The exhaust shall be a production exhaust with a maximum noise level within the permitted legal tolerance (max. 98dBA).

f) Suspensions shall comply with the Group N Regulations.

g) Underbody protection is authorised (complying with the Group N Regulations).

h) The fitting of a safety rollbar is authorised.

i) Safety harnesses in colours similar to those of the interior of the car are authorised.

j) Bucket seats in colours similar to those of the interior of the car are authorised.

k) Two additional road-homologated headlamps are authorised.

l) The rims are free and shall be fitted with:

m) Road-homologated series production tyres for asphalt (no competition tyres).

n) Free tyres for gravel.

o) The crew may use a «light» intercommunication system (without helmets).

8.5.5 - Sanctions

Drivers who fail to respect these instructions may be sanctioned up to refused start or exclusion.

The entry fees will not be reimbursed by the Organising Committee.

9 - RUNNING OF THE COMPETITION

9.1 - Start

9.1.1 - Invited crews must present the car at the start area **Staromestske namesti, Mlada Boleslav, GPS: 50.4111464N, 14.9027556E**: on Friday 10.7.2015 at the time to be notified during scrutineering. The start area will be made available at the time scheduled in the programme. This is the only start ramp provided.

9.1.2 - The cars will be started at one minute intervals as stated in the Rally programme. Any crew reporting late at the start of the event, leg or section shall be penalised by 10 seconds for every minute late. Cars arriving more than 15 minutes late will not be allowed to start. Since the crews have 15 minutes within which to report to the start of the event, leg or section, if they report within these 15 minutes, the exact starting time shall be stamped on the time card.

9.1.3 - Crews are obliged to have their passage checked at all points mentioned on their time card, and in the correct order. The target time for covering the distance between two time controls will be shown on the time card.

9.1.4 - Hours and minutes will always be shown from 00.01 to 24.00. Throughout the Competition the official time will be that indicated in Article 3.5.

9.1.5 - Each crew will be provided with a Road Book, which will detail the compulsory route to be followed throughout the Rally.

9.2 - Controls - General provisions

9.2.1 - All controls, i.e. passage and time controls, start and finish of special stages, regrouping and neutralisation zone controls, will be indicated by means of FIA-approved standardised signs (see Appendix 1).

9.2.2 - The beginning of the control area is marked by a warning sign of yellow colour. At a distance of about 25m the position of the control post is indicated by a final sign red. The warning finish sign at the end of special stages will be placed at about 300m before the finish line.

9.2.3 - All control areas (i.e. the area between the first warning sign and the final sign are considered to be «Parc Fermé» (see Article 9.6).

9.2.4 - The stopping time within a control area must not exceed the time necessary for carrying out control operations.

9.2.5 - It is strictly forbidden, under pain of penalty up to exclusion:

a) to enter a control area in any direction other than that of the Rally,

b) to cross over or re-enter a control area once checking-in has taken place at this control.

9.2.6 - The target check-in time is the responsibility of the crews alone, who may consult the official clock on the control table. The post marshals may not give them any information on this target check-in time.

9.2.7 - Control posts shall be ready to function 15 minutes before the target time for the passage of the 1st crew. Unless the clerk of the course decides otherwise, they will cease to operate 15 minutes after the target time for the last crew, plus exclusion time.

9.2.8 - Crews are obliged to follow the instructions of the road marshal in charge of any control post. Failure to observe this may lead to exclusion at the discretion of the stewards.

9.2.9 - Road marshals and post chiefs shall be distinguished as follows:

- road marshals will wear yellow jackets marked *flash*.

- post chiefs will wear orange *colour* jackets marked.

9.3 - Passage Control - Time Control - Exclusion

9.3.1 - Passage Control

At these controls, the post marshals must simply stamp the time card as soon as this is handed in by the crew, without mentioning the time of passage. The absence of a stamp from a passage control may result in exclusion, except where the provisions of Article 9.3.6.1 apply.

9.3.2 - Time controls

At these controls, the post marshals shall mark on the time card the time at which the card was handed in. The absence of a stamp from a time control may result in exclusion, except where the provisions of Article 9.3.6.1 apply.

To be classified for the Rally, the Driver has to pass the last time control of the event **Staromestske namesti, Mlada Boleslav** - final arrival.

9.3.3 - Check-in/out procedure

9.3.3.1 Check-in procedure begins the moment the vehicle passes the zone entry sign. Between the zone entry sign and the control post, the crew is forbidden to stop for any reason or to drive at an abnormally slow speed.

9.3.3.2 Clocking the card can only be carried out if the two crew members and the car are in the control zone and in the immediate vicinity of the control table.

9.3.3.3 The check-in time corresponds to the exact moment at which one of the crew members hands the time card to the time keeper. Then, either by hand or by means of a stamp, the time-keeper marks on this card the actual time at which the card was handed in.

9.3.3.4 The target check-in time is the time obtained by adding the time allowed to complete the road section to the start time for this section, these times being expressed to the minute.

9.3.3.5 The crew does not incur any penalty for checking in before time if the vehicle enters the control zone during the target check-in minute or the minute preceding it.

9.3.3.6 The crew does not incur any penalty for being late if the act of handing the card to the time-keeper takes place during the target check-in minute; e.g. a crew who is supposed to check in at a control at 18h 58' shall be considered on time if the check-in takes place between 18h 58' 00" and 18h 58' 59".

9.3.3.7 Any difference between the actual check-in time and the target check-in time shall be penalised as follows:

a) for late arrival: 10 seconds per minute or fraction of a minute,
b) for early arrival: 1 minute per minute or fraction of a minute.

9.3.3.8 Finally, if it is found that a crew has not observed the rules for the check-in procedure as defined above (and especially by entering the control zone more than a minute before the actual check-in time) the chief marshal at the control post must make this the subject of a written report to be sent immediately to the clerk of the course.

9.3.4 - Time of leaving control

9.3.4.1 If the next road section does not start with a special stage, the check-in time entered on the time card shall constitute both the arrival time at the end of the road section and the starting time of the following one.

9.3.4.2 Conversely, when a time control is followed by a start control for a special stage, the following procedure shall be applied:

a) These two posts shall be included in a single control area (see Article 9.2) whose signs shall be as follows:

- yellow board with clock symbol: beginning of zone,
- red board with clock symbol: time control post at a distance of approx. 25m,
- red board with flag symbol: start of special stage at a distance of 50 to 200m,
- beige board with flag symbol: end of control sign 50m further on.

b) At the time control at the finish of a road section, the post marshal will enter on the time card the check-in time of the crew together with its provisional start time for the following road section.

There must be a 3 minutes gap to allow the crew to prepare for the start.

c) Immediately after checking in at the time control the crew will go to the start of the special stage. The marshal in charge of this post will enter the provisional time for the start of the stage on the stage sheet, which usually corresponds to the provisional starting time for the road section. He will then start the crew according to the procedure laid down in the Regulations (see Article 9.5.4).

9.3.4.3 If a difference exists between the two entries, the starting time of the special stage will be binding, unless the stewards decide otherwise.

9.3.4.4. In the case of a flat tyre, an additional 5 minutes will be allowed for repairs.

9.3.5 - Exclusion

9.3.5.1 Any delay exceeding 15 minutes at the target time between two time controls, or a total delay exceeding 30 minutes at the end of each section and/or leg of the Rally, will result in the exclusion of the crew except where the provisions of Article 9.3.6 apply.

9.3.5.2 Under no circumstances may crews having exceeded their maximum delay attempt to reduce this delay by arriving early at controls, neither shall penalties for early arrival be taken into account when calculating any delay exceeding the maximum permitted delay which results in exclusion.

For example:

Road section A

Start 12h00 - target time 1h00 - check-in time 13h10'

Penalty for late arrival: 100"

Delay counting towards exclusion: 10 minutes

Road section B

Target time 1h30' - check-in time 14h20'

Penalty for early arrival: 1200"

Delay counting towards exclusion: 10 minutes (not combined)

Road section C

Target time 2h00' - check-in time 16h30'

Penalty for late arrival: 100 additional seconds

Delay counting toward exclusion: 10 minutes

Total road section controls A + B + C

Total penalties (for late and early arrivals): 100" + 1200" + 100" = 1400 seconds

Total delay counting toward exclusion: 10' + 10' = 20 minutes

9.3.5.3 The exclusion time may be increased at any point by the stewards, upon the proposal of the clerk of the course. The crews concerned shall be informed of this decision as soon as possible.

9.3.5.4 Exclusion for exceeding the maximum permitted delay may only be announced at the end of a section or at the end of a leg.

9.3.6 - Catching up (not applicable to the last leg)

9.3.6.1 Provision shall be made for a Driver who has missed, during a leg, a special stage or a circuit event and/or who did not check-in at the last time control of the leg, or place the car in Parc Fermé, to catch up and be re-admitted to the following leg. He will be given the worst overall time achieved in his category in that particular leg. If there are no finishers in his category then the next worst time in any appropriate category may be used. In all cases the penalty will be increased by a penalty of 60 seconds for each special stage missed.

He may be re-admitted to the following leg unless, prior to the posting of the classification for that leg, he informs the clerk of the course in writing of his intention to withdraw from the event. Those Competitors wishing to be re-admitted must report to the Parc Fermé 30 minutes before the start of the next leg.

The clerk of the course or stewards may order that the car be re-scrutineered.

This catching up is not applicable for the last leg of the Competition and in order to be classified, the car must have passed the last time control of the Competition within the time allowed.

9.3.6.2 The starting order for the newly admitted cars will be at the discretion of the clerk of the course.

9.4 - Regrouping controls

9.4.1 - Regrouping controls will be set up along the route. Their entry and exit controls shall be subject to the general rules governing the control posts (Article 9.2).

9.4.2 - The purpose of these regroupings will be to reduce the intervals which may occur between crews as a result of late arrivals and/or withdrawals. Thus the starting time from the regrouping control and not its duration must be taken into account.

For example: 120 cars at the start of the Rally - first regrouping of 4 hours - starting time from the regrouping control: 12h01:

a) target time for the arrival of car no. 1 at the regrouping control: 8h01,

target time for the arrival of car no. 120 at the regrouping control: 10h.

b) actual arrival time of car no. 1 at the regrouping control: 8h45,

actual arrival time of car no. 120 at the regrouping control: 11h50 (60 cars have withdrawn during this part of the Rally).

c) starting time of car no. 1: 12h01,

starting time of car no. 120: 13h00.

The respective duration of stopping times should therefore have been:

- 3h16' for car no. 1

- 1h10' for car no. 120.

9.4.3 - On their arrival at these regrouping controls, the crews will hand to the post marshal their time card. The crews will receive instructions on their starting time. They must then drive their cars immediately and directly to the Parc Fermé. Engines must be stopped.

9.5 - Special Stages

9.5.1 - Special Stages are tests on roads closed specially for the event.

9.5.2 - During these events, all those in the car must wear, under pain of exclusion, approved crash helmets and flame-resistant overalls, according to Appendix L, Chapter III, Article 2 specifications.

9.5.3 - Crews are forbidden to drive in the opposite direction to that of the Rally, under pain of exclusion.

9.5.4 - Starts of special stages will be given as follows: when the car with its crew on board has stopped in front of the starting control, the marshal will enter the time scheduled for the start of the car in question on the stage sheet, and he will hand this document back to the crew. The start will be given by the marshals.

A penalty of 2 minutes shall be imposed on any crew which fails to start within 20 seconds of the starting signal.

9.5.5 - During the Rally, one «Slalom» stage may be run. The time stated in the present Regulations will be allocated to the crews, plus a penalty of 2 seconds for each displaced bollard.

9.5.6 - The start of the special stage may only be delayed in relation to the scheduled starting time by the post marshal in a case of «force majeure». In the event of a crew being late, the chief post marshal will enter a new time and the delay will then be considered as the delay recorded on a road section. It will therefore be taken into consideration for the calculation of the exclusion time.

9.5.7 - A false start, particularly one made before the signal has been given, is penalised as follows:

1st offence: 10 seconds,

2nd offence: 1 minute,

3rd offence: 3 minutes.

further offences: at the stewards' discretion.

These penalties do not prevent the stewards from imposing heavier penalties if they judge it necessary.

9.5.8 - Special stages will end in a flying finish, stopping between the warning sign and the stop sign being forbidden on pain of exclusion. Timing will be done on the finish line, which must have print-out equipment backed up by stop watches. At a distance of 200 to 300m after the finish, the crew must report to a control (Point Stop) indicated by a red 'STOP' sign to have its finishing time entered on the time sheet. If the timekeepers cannot give the exact finishing time to the marshals immediately, the latter will only stamp the crew's sheet and the time will be entered at the next neutralisation zone or regrouping control.

9.5.9 - If, due to a fault of the crew, the time entry cannot be made, the following penalties shall be imposed:

a) at the start: exclusion;

b) at the «STOP» (Stop Point): 300" time penalty.

9.5.10 - The times recorded by the crews in each special stage, expressed in hours, minutes and seconds 1/10 second, shall be added to their other penalties expressed in time.

9.5.11 - During a special stage, assistance is forbidden. Any breach of this rule will result in the offending Competitor being automatically excluded from the event by the panel of stewards.

9.5.12 - The start intervals for special stages must comply with the same dispositions as those laid down for the start of the leg in question.

9.5.13 - Termination of a special stage

When a special stage has to be definitively stopped for any reason whatsoever before the last crew has covered it, the results for the stage may be established by allocating to each crew who has been unable to complete the stage, the slowest time set before the termination. These results may be drawn up even if only one crew has been able to cover the stage in normal racing conditions. Only the stewards may apply this disposition after the clerk of the course has given the reasons for the termination. Should the stewards consider the slowest time set as abnormal, they may take as the scratch time one of the four slowest times which seems the most suitable. However, no crew who is totally or partially responsible for stopping a stage may benefit from this measure. This crew will be given the time which it might have made if this is greater than the scratch time awarded to other crews.

9.5.14 - Any crew refusing to start in a special stage at the time and in the position allocated to it shall be given a penalty of 300".

9.5.15 - On special stages, the following rules apply:

a) If, during a special stage, a competitor is caught up by a faster competitor who gives headlight or horn signals, the slower competitor is obliged to let the faster one pass, even if he has to stop on the right or left side of the road, showing with the appropriate indicator that he is ready to be overtaken. Infringement may result in a fine or exclusion, depending on the decision of the stewards,

b) Stopping on or directly before or after a bend, or moving the car across the course or in a direction other than that of the Rally, is strictly forbidden. Drivers who have to stop for an emergency must stop their car at the side of the road and warn the Drivers following by appropriate means (e.g. red triangle),

c) If the road is blocked because of an accident, it must be cleared as soon as possible to allow safety vehicles or ambulances through. Damaged cars must be kept clear of the road until Rally officials have re-opened the stage to traffic.

Each infringement will result in a penalty which may go as far as exclusion.

9.6 - Parc Fermé

9.6.1 - Cars shall be subject to Parc Fermé rules:

a) from the moment they enter the starting area, a regrouping area or an end of leg, until they leave,

b) from the moment they enter a control area until they leave it,

c) from as soon as they reach the end of the Rally until the time for lodging protests has expired.

9.6.2 - While the vehicles are subject to Parc Fermé rules:

a) any repairs or refuelling are strictly forbidden, under pain of exclusion,

b) however, if the scrutineers note that a vehicle seems to be in a condition which is not compatible with the normal road use, they must immediately inform the clerk of the course thereof who may request that the car be repaired,

c) in this case, the minutes used to carry out the repairs will be considered as the same number of minutes' delay recorded in a road section. After repairs, the crew will possibly be given a new starting time.

9.6.3 - As an exception, and under the supervision of the competent marshal, the crew may, while in the Parc Fermé at the start, regrouping zone or end of leg:

- change a punctured or damaged tyre using the equipment on board,

- change the windscreen with the possibility of outside help.

These repairs must be completed before the starting time. otherwise a penalty shall be imposed in accordance with the provisions stated in Article 9.6.2.c.

9.6.4 - As soon as they have parked their cars in the Parc Fermé, the Drivers will leave the Parc Fermé and no crew member will be allowed to re-enter.

9.6.5 - To leave a Parc Fermé for the start, regrouping halt or end of leg, the crew shall be allowed to enter the Parc Fermé 10 minutes before their start time.

9.6.6 - If a vehicle is unable to move under its own power:

At a Parc Fermé at a start, regrouping halt or end of leg, only the officials on duty or the members of the crew are authorised to push a competing vehicle inside or at the entrance to or exit from a Parc Fermé at a start, regrouping halt or end of leg. An additional battery may be used to help to start the car but cannot be carried on board the car.

9.6.7 - Any infringement of the Parc Fermé Regulations shall (or, in the case of catching up, may) result in exclusion from the Rally.

9.6.8 - After the Rally, all cars which have crossed the last time control shall be driven, under the supervision of the officials of the Competition, to a Parc Fermé where they shall remain for at least 30 minutes after the posting of the provisional results and until the stewards order their release.

Any classified car which is unable to cross the line and/or reach the Parc Fermé under its own power will immediately upon such disability occurring be placed under the exclusive control of the marshals and scrutineers who, as soon as this is

possible, will conduct the car to the Parc Fermé. Cars which have not been placed in the Parc Fermé will not be classified.

10 - ADMINISTRATION AND CHECKING - PENALTIES

10.1 - Checking before the start and during the Rally

10.1.1 - Any team taking part in the Rally, must arrive at scrutineering with its full crew and car in accordance with the published timetable. Any car reporting to the scrutineering area outside the prescribed time limits will not be allowed to start, except in the case of «force majeure» duly recognised as such by the stewards. The crew must present the FIA HTP to the FIA eligibility delegate who may keep it until the end of the event. If this is not submitted, the car may not start.

10.1.2 - The checks carried out before the start will be of a completely general nature (checking Licences, driving licences, make and model of the car, apparent conformity of the car with its HTP, essential safety items, conformity of the car with the National Highway Code, etc.). This shall be followed by:

- identification of crew. Each member must have with him one recent identity photo:
- identification of the vehicle, the chassis and cylinder block of which may be «marked», at the organiser's discretion.

10.1.3 - To be allowed to start, all cars must be equipped with extinguisher(s) according to Article 5.7.1 of Appendix K.

10.1.4 - No car will be allowed to start unless it complies with the FIA safety regulations. At any time during the event, additional checks may be carried out regarding the crew or the vehicle.

The competitor is responsible for the technical conformity of his car throughout the entire duration of the Rally, under penalty of exclusion.

10.1.5 - Should identification marks (art. 10.1.2) be affixed, it is the responsibility of the crew alone to see that these are protected until the end of the Rally. If they are missing, the car will be excluded from the Competition immediately.

10.1.6 - Any fraud discovered, and in particular showing as intact identification marks which have been altered, will result in the exclusion of the crew from the Competition, as well as any Competitor or crew who has helped or been involved in carrying out the infringement. This will not prejudice the fact that the National Sporting Authority (ASN), to which Competitor or accomplice belongs, may be asked to impose heavier sanctions.

10.1.7 - The following documents will be checked:

- a) International Competitor's Licence,
- b) International Licences of both Drivers,
- c) driving licences of both Drivers,
- d) car registration papers,
- e) car insurance papers,
- f) identity card with recent photos of both Drivers,
- g) authorisation to compete abroad for Competitors with Licences issued by another ASN than the organising ASN,
- h) FIA HTP for the vehicle, in compliance with Article 2 of Appendix K. The organiser will retain this form for the duration of the event.

10.2 - Final control

10.2.1 - As soon as each crew reaches the finish, they shall drive their car to the Parc Fermé. A check shall be made to verify:

- its conformity with the car submitted at initial scrutineering,
- if there is any reason to impose any of the penalties specified under Article 8.2.

10.2.2 - The absence of any of the identification marks, as per Article 10.1.5, shall result in exclusion from the Competition.

10.2.3 - Without it being compulsory, scrutineering involving the dismantling of the vehicles may be carried out at the absolute discretion of the stewards ex-officio or following a protest or upon the decision of the clerk of the course. If this dismantling does not follow a protest, the Competitor will have to pay the reasonable expenses which exercise of the powers

mentioned herein may entail. In case of dismantling following a protest, Article 11 of these Regulations will apply.

10.2.4 - See Article 11.

10.2.5 - Those vehicles which are to be subjected to final scrutineering, as ordered by the stewards, should be announced by a notice at the entrance to the Parc Fermé.

10.2.6 - A car not conforming to Appendix K and/or its HTP may be excluded from the Competition.

10.2.7 - The HTP will be returned to the Competitor at the Parc Fermé and at the latest after the final control.

11 - PROTESTS - APPEALS

11.1- All protests shall be lodged in accordance with the stipulations of the Code (see Article 13.1 and following)

11.2 -All protests must be lodged in writing and handed to the clerk of the course together with the sum 500 € (14 000 CZK) which shall not be returned if the protest is judged unfounded. If the protest requires the dismantling and re-assembly of different parts of a car, the claimant must pay an additional deposit, the amount of which will be decided by the stewards.

11.3 -The expenses incurred by the work and by the transport of the vehicle shall be borne by the claimant if the protest is unfounded, or by the Competitor against whom the protest is lodged if the claim is upheld.

11.4 -If the claim is unfounded, and if the expenses incurred by the protest (scrutineering, transport etc.) are higher than the deposit amount, the difference shall be borne by the claimant. Conversely if the expenses are less, the difference shall be returned to him.

11.5 -The entrants may lodge an appeal against the decisions of the stewards, in conformity with the stipulations of Article 14.3 of the Code.

12 - FINAL RESULTS

12.1 - Penalties shall be expressed in hours, minutes and seconds. The final results shall be determined by adding the times obtained in the special stages and the penalties incurred during the road sections and any other penalties expressed in time. The crew with the lowest total shall be proclaimed the overall winner, the next lowest second and so on. The period and class results shall be determined on the same basis. To be classified for the Rally, the car has to pass the last time control of the Competition **Staromestske namesti, Mlada Boleslav.**

12.2 - In the event of a dead heat, the competitor who accomplished the best time for the first special stage will be proclaimed the winner. If this is not sufficient to be able to decide between the competitors, the times of the 2nd, 3rd, 4th and 5th special stages shall be taken into consideration.

12.3 - An independent general final result and class final result will be issued for each category of eligible cars.

12.4 - The results shall be posted in accordance with the programme of the Rally.

12.5 - The final result can be protested until 30 minutes after the results are posted and approval by the panel of stewards. However, a provisional result will be issued at the end of the 1st leg to establish the starting order of the 2nd leg.

12.6 - A separate classification will be posted for the crews registered in the FIA Championship for the Categories 1, 2, 3 and 4.

13 - PRIZES - CUPS

Prizes will be awarded according to the final results of the Rally.

The following cups will be awarded as a minimum to both Driver and Co-driver:

- Winners in each category.
- Winners in each class.

Where there are three or more classified in either category or class, awards for 2nd place will be given.

Where there are six or more classified in either category or class, awards for 3rd place will be given.

The organisers may increase the above awards according to participation.

14 - PRIZE-GIVING

The prize-giving will take place on Sunday 12.7.2015, 17:00, Skoda Auto Museum, Trida Vaclava Klementa, Mlada Boleslav, GPS:50.4187797N, 14.9140264E)

All the members of the crew must be present at the prize-giving. Crews who are not present at the prize-giving may forfeit their prizes; however, the final results will not be modified.

Petr Eliáš, M.Sc.
Clerk of the Course
RALLY BOHEMIA HISTORIC

Appendix 1 : FIA standard Rally control signs

FIA STANDARD RALLY CONTROL SIGNS

TIME CONTROL



Pre sign YELLOW
Control sign RED

SPECIAL STAGE START



Control sign RED

SPECIAL STAGE FINISH



Pre sign YELLOW
Finish sign RED

SPECIAL STAGE STOP CONTROL



Stop sign RED

END OF CONTROL ZONE



End of Control BEIGE

PASSAGE CONTROL



Pre sign YELLOW
Control sign RED

REFUEL ZONE START



Zone start BLUE

REFUEL ZONE END



Zone finish BLUE

RADIO COMMUNICATION POINT

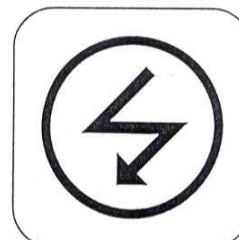

Pre sign YELLOW
Radio point sign BLUE

SAFETY MEDICAL POINT

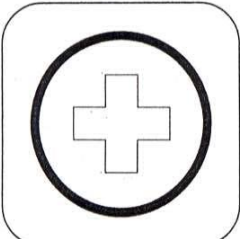

Pre sign YELLOW
Medical point sign BLUE

TYRE MARKING















Sign BLUE
Marker pen RED

TYRE MARK CHECKING



Sign BLUE
Magnifier RED

(Diameter of the signs: about 70 cm)

Direction Sens du parcours	Control type Nature du contrôle	CONTROL ZONE ZONE DE CONTRÔLE			Direction Sens du parcours
⇒	PASSAGE CONTROL CONTRÔLE DE PASSAGE	YELLOW SIGNS Beginning of Control Zone PANNEAUX JAUNES Début de Zone de Contrôle 	RED SIGNS Compulsory Stop PANNEAUX ROUGES Arrêt obligatoire  PC CP	BEIGE SIGNS End of Control Zone PANNEAUX BEIGES Fin de Zone de Contrôle 	⇒
⇒	TIME CONTROL CONTRÔLE HORAIRE		← 25 m →  TC CH	← 25 m → 	⇒
⇒	TIME CONTROL AND SS START CONTROLE HORAIRE ET DEPART D'ES		← 25 m →  TC CH	50 m ← → min  25 m ← → SSS Dd'ES	⇒
⇒	END OF SS FIN D'ES		← 100 m →  100 - ← → 300 m FLYING FINISH NON-STOP LIGNE D'ARRIVEE VEHICULE LANCE	25 m ← → STOP SSF Ad'ES 	⇒

Appendix 2 : Time Schedule Leg 1

Saturday 11th July 2015 / Sobota 11. 7. 2015 LEG 1 / 1. ETAPA

SS/RZ TC/ČK	Location Místo	SS dist. RZ délka	Liaison dist. Trať bez RZ	Total dist. Spoj. úsek	Target time Jízdní doba	First car due Čas 1. jezdce
Ceremonial START - Staroměstské náměstí / Staroměstské Square - Pátek / Frid: 19:00						
1	Sychrov					14:00
SS1	Sychrov I.	19,58				14:03
Refuel RZ 1 (Rychnov)						
Distance to next refuel (Mladá Boleslav)		24,46	82,72	107,18		
2	Desná		22,22	41,80	0:59	15:02
SS2	Šumburk I.	16,29				15:05
3	Dupanda		18,66	34,95	0:45	15:50
SS3	Bzí I.	5,82				15:53
4	Mladá Boleslav - Gate 7		41,13	46,95	0:57	16:50
SS4	Bondy	2,35				16:53
4A	Regrouping IN		1,78	4,13	0:17	17:10
Regrouping (Gate 11) - Přeskupení						0:30
4B	Regrouping OUT Service IN					17:40
Service A (Mladá Boleslav)		(44,04)	(83,79)	(127,83)	0:30	
4C	Service OUT					18:10
Refuel RZ 2 (Gate 11)						
Distance to next refuel (Rychnov)		19,58	33,78	53,36		
5	Sychrov		32,71	32,71	0:45	18:55
SS5	Sychrov II.	19,58				18:58
Refuel RZ 3 (Rychnov)						
Distance to next refuel (Mladá Boleslav)		22,11	79,69	101,80		
6	Desná		22,22	41,80	0:59	19:57
SS6	Šumburk II.	16,29				20:00
7	Dupanda		18,66	34,95	0:45	20:45
SS7	Bzí II.	5,82				20:48
7A	Parc Ferme IN		39,88	45,70	0:50	21:38
7B	Parc Ferme OUT - Flexi Service IN					
Flexi Service B (Mladá Boleslav)		(41,69)	(113,47)	(155,16)	0:45	
7C	Flexi Service OUT - Parc Ferme IN					23:30
All cars must be returned to Parc Ferme no later than						

Section 1

Section 2

Day 1 totals

85,73

197,26

282,99

30,29%

Appendix 2 : Time Schedule Leg 2

Sunday 12th July 2015 / Neděle 12. 7. 2015**LEG 2 / 2. ETAPA**

SS/RZ TC/ČK	Location Místo	SS dist. RZ délka	Liaison dist. Trať bez RZ	Total dist. Spoj. úsek	Target time Jízdní doba	First car due Čas 1. jezdce
7D	Parc Ferme OUT - Service IN					8:00
Service C (Mladá Boleslav)		(00,00)	(00,00)	(00,00)	0:15	
7E	Service OUT					8:15
Refuel RZ 4 (Gate 11)						
Distance to next refuel (Mladá Boleslav)		32,96	41,10	74,06		
8	Bezdědice		22,18	22,18	0:35	8:50
SS8	Lobeč I.	11,96				8:53
9	Skalsko		7,36	19,32	0:25	9:18
SS9	Vinec I.	15,98				9:21
10	Mladá Boleslav - airport		8,64	24,62	0:32	9:53
SS10	Staroměstská I.	5,02				9:56
10A	Regrouping IN		2,92	7,94	0:19	10:15
Regrouping (Gate 11) - Přeskupení					0:30	
10B	Regrouping OUT Service IN					10:45
Service D (Mladá Boleslav)		(32,96)	(41,10)	(74,06)	0:30	
10C	Service OUT					11:15
Refuel RZ 5 (Gate 11)						
Distance to finish (Mladá Boleslav)		32,96	38,30	71,26		
11	Bezdědice		22,18	22,18	0:35	11:50
SS11	Lobeč II.	11,96				11:53
12	Skalsko		7,36	19,32	0:25	12:18
SS12	Vinec II.	15,98				12:21
13	Mladá Boleslav - airport		8,64	24,62	0:32	12:53
SS13	Staroměstská II.	5,02				12:56
13A	Finish TC and Holding Area (STOP SS13)		0,12	5,14	0:10	13:06
Podium Ceremony - Staroměstské náměstí / Staroměstské Square						13:30

Section 3

Section 4

Day 2 totals	65,92	79,40	145,32	45,36%
---------------------	--------------	--------------	---------------	---------------

TOTALS OF THE RALLY					
Leg	SS	SS	Liaison	Total	%
1	7	85,73	197,26	282,99	30,29%
2	6	65,92	79,40	145,32	45,36%
Overall Totals	13	151,65	276,66	428,31	35,41%

Appendix 3 : Competitors' relations officers



Zdeněk Bělák
+420 602 530 321



Jakub Hofbauer
+420 777 306 344



Pavel Konečný
+420 774 594 008

Friday 10th July 2015

17:30 – 19:30 Administrative check
19:30 – 21:00 Ceremonial start

Mladá Boleslav, Dům kultury
Mladá Boleslav, Staroměstské náměstí

Saturday 11th July 2015

7:00 – 10:30 Technical scrutineering
13:50 – 14:50 Start rally (TC1)
17:00 – 18:30 Regrouping (TC4A)
21:30 – 23:30 Park Fermé (TC7A)

Mladá Boleslav, 11th gate Škoda Auto
Sychrov
Mladá Boleslav, 11th gate Škoda Auto
Mladá Boleslav, 11th gate Škoda Auto

Sunday 12th July 2015

8:00 – 9:30 Start leg 2 (TC7D)
10:00 – 11:15 Regrouping (TC10A)
13:00 – 14:30 Finish of rally (TC13A)
15:10 – 15:50 Publishing of prelim. results

Mladá Boleslav, 11th gate Škoda Auto
Mladá Boleslav, 11th gate Škoda Auto
Mladá Boleslav, Staroměstské náměstí
Mladá Boleslav, Dům kultury

Appendix 4 : GPS tracking system of ONI®

1. General provision

All competition rally cars are required to be equipped with the ONI® tracking system during the rally. The ONI® tracking system is the property of A.C.C.R.; the competitors get it for a flat rate fee of **100 CZK/unit and 300 CZK/unit's holder** if not already fitted in the car. The return of the unit is guaranteed by depositing the driver's rally licence or **1000 CZK** at the GPS system administrator. This guarantee is to be given back or paid back at the return of the unit. The competitor is to pay for any eventual destruction, non-return or damage to the unit to the provider pursuant to the approved price list. If not, the driver's licence or the money deposit is not to be returned.

2. ONI® tracking system distribution

ONI® tracking system requires every car to be fitted with an entire tracking unit's holder before the rally. The holder includes:

- tracking unit bracket including cables and mounting accessories,
- 2 aerials (roof and inner ones),
- controls such as:
 - alarm cancel button / call for help / yellow flag confirmation
 - LED indicator / to indicate yellow flag

ONI® manager provides **all regular rally participants** in the CR with the above mentioned parts to be fitted in their cars permanently.

Foreign competitors and other drivers starting sporadically are provided with the entire disposable holder just before the event. More information is to be available at the check-in.

After the arrival at the area before the technical scrutiny, the unit administrator checks the holder assembly, installs the tracking unit and tests the tracking system.

At the end of the rally or after DNF, the tracking unit is to be (eventually the entire tracking system) given back to the system administrator. The units dismount is usually carried out at the service parking site before the rally's finish line.

3. The entire holder assembly in the car

3.1 The competitors are required to follow strictly the installation manual of the manufacturer (NAM system, a.s.) while assembling the tracking unit holder, roof and inner aerials, and individual controls; to keep the unit in a good condition for the entire time; to protect it from damage and fouling/dirt (especially the connectors).

3.2 The unit for foreigners and drivers starting sporadically at the rally is equipped with the magnetic roof aerial and the controls which are all placed in one common box. The competitor is to choose an appropriate place to fit the unit on within the reach of both crew members; and to prepare potentialities for its fitting.

4. The unit operation during the rally

To operate the unit, the crews are to meet all instructions mentioned in the user's manual issued by the manufacturer (NAM system, a.s.).

The procedure in individual events at SS:

- Accident (crash detection)

- alarm is set off immediately, the siren sounds/beeps in the car
- if no help is necessary, alarm and siren are silenced by pressing the button for a short time (1 sec)

- Stop (more than 30 sec)

- siren sets off after 30 sec
- if no help is necessary, alarm and siren are silenced by pressing the button for a short time (1 sec)
- alarm can be off immediately after the stop by pressing the button for a short time

- Request for help

- in cases when any immediate help at SS is necessary (i.e. at health hazard, etc.)
- Call for help is activated by pressing the button for a long time (3 sec) – the siren sets off

- Yellow flag

- in case the yellow flag is hung out at SS, the rally management sends an impulse for the selected crews to light up the yellow LED installed in the visual field of the crew. To confirm the yellow flag reception, the crew presses the button for a short time (1sec). The yellow LED is off.

- **Warning: if the alarm is not cancelled, it is considered as the request for help!!!**

5. Speed limit check during the reconnaissance

The crew is to follow the traffic rules of the CR during the reconnaissance. Breaking the rules especially exceeding the speed limit is to be checked by the tracking unit of ONI[®] system. Furthermore, there may be other checks carried out by Police CR including standard sanctions. ONI[®] system tracking unit checks the speed on-line in every moment during the reconnaissance.

Each crew picks the ONI[®] system tracking unit up along with the itinerary. The guarantee is either the driver's licence or the money deposit of 1 000 CZK which is to be referred to the ONI[®] tracking unit administrator after the reconnaissance is finished.

To install the tracking unit, to plug it in and to use it throughout the reconnaissance is obligatory for everyone; subject to the article 3; the reconnaissance programme.

To check the speed during the reconnaissance, NCL 11 PP units are to be used.



NCL11PP unit is plugged in the power supply voltage. If the unit is on move, it is battery-powered for 13 hours; if inactive, for 40 hours. Keep the unit under voltage permanently if the power supply voltage is available in the car. If not available, get the unit started in another car and transfer it back to the one without the power supply voltage.

After the connector is plugged in the cigarette lighter outlet in the car, the red LED diode indicates the unit's activation and power supply. This LED flashes if it gets the GPS signal from satellites. Power supply voltage in the cigarette lighter outlet is activated in some cars after the ignition key is turned. If the car moves, the green LED is on.

Visual indication of power supply:

Power supply is OK, a functional unit:



No power supply, a non-functional unit:



If the unit changes into "driving mode" (GPS and accelerometer change) the green LED is on:



Buttons are to be used to switch off the units while collecting the units. The instruction how to switch the unit off is available on each unit. To switch it off, press T2 button 3times. The blue LED is on. If not switched off, the unit is off automatically after being discharged.

The officials are to fill in the form included in the transport case. They write down non-functional units' numbers. The manufacturer checks the defective units listed in the form only. If not done, the defective units are used at another event without being repaired.

No unit used (or not plugged in) is to be penalized.

Every attempt to falsify, handle or interfere into the unit in the car during the reconnaissance; or every unit which makes data impossible to be recorded due to external interference is to be reported to the commissars. They are allowed to impose punishment or exclude from the race.

The director of the rally has the power to make a decision on the seriousness of the offence and its recurrence. Speeding may be penalized in accordance with the clause 20.2 SPR.

6. Manuals and further information: www.onisystem.cz/rally

Appendix 5 : Supercharged engines of Category 4 Group A and Group N cars of Period J2

All supercharged cars of Period J2 must be fitted with a restrictor fixed to the compressor housing.

This restrictor, which is compulsory in rallies, is not prohibited in other competitions, should a competitor decide to use it.

All the air necessary for feeding the engine must pass through this restrictor which must respect the following dimensions:

The maximum internal diameter of the restrictor is **36mm for Group N** (Series Production Touring Car) and **38mm for Group A** (Competition Touring Car), maintained for a minimum distance of 3mm measured downstream of a plane perpendicular to the rotational axis situated at a maximum of 50mm upstream of a plane passing through the most upstream extremities of the wheel blades, this distance being measured along the neutral axis of the intake duct (see drawing below).

This diameter must be complied with, regardless of the temperature conditions.

The external diameter of the restrictor at its narrowest point must be less than 42mm for Group N and 44mm for Group A, and must be maintained over a distance of 5mm to each side.

The mounting of the restrictor onto the turbocharger must be carried out in such a way that two screws have to be entirely removed from the body of the compressor, or from the restrictor, in order to detach the restrictor from the compressor.

Attachment by means of a needle screw is not authorised.

For the installation of this restrictor, it is permitted to remove material from the compressor housing, and to add it, for the sole purpose of attaching the restrictor onto the compressor housing.

The heads of the screws must be pierced so that they can be sealed.

The restrictor must be made from a single material and may be pierced solely for the purpose of mounting and sealing, which must be carried out between the mounting screws, between the restrictor (or the restrictor/compressor housing attachment), the compressor housing (or the housing/flange attachment) and the turbine housing (or the housing/flange attachment) (see drawing below).

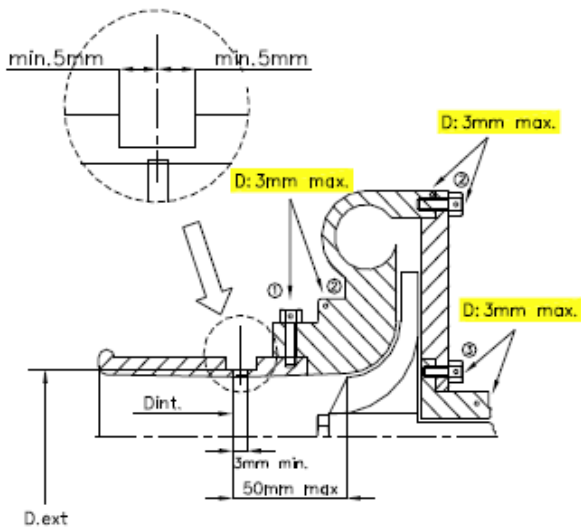

- ① trou pour bride ou bride/carter de compression
hole for restrictor/compressor housing
- ② trou pour carter de compression ou carter/flasque
hole for compressor housing or housing/flange
- ③ trou pour carter central ou carter/flasque
hole for central housing or housing/flange

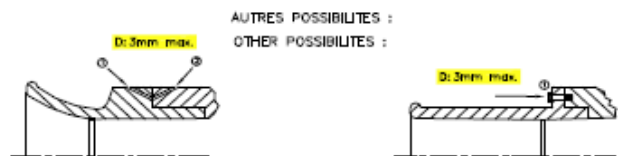

Note: The nominal cylinder capacity of cars up to and including Period J1 with a supercharged engine will be multiplied by a coefficient of 1.4 and that of Period J2 cars by a coefficient of 1.7.

Appendix 6: Advertising

